

Stocking and Distribution..

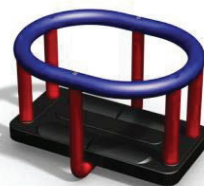

Pricelist – January. 2015

**Commercial Playground
Components**



PATENTED SOLUTION



EXAMPLES OF CONNECTION

Rope products like hanging bridges, climbing nets & other rope equipment.
For dia. 13-18mm



6-10mm universal usage where chain or other connection is required.
For dia. 6-10mm



5mm universal usage where chain or other connection is required.
For dia. 5mm

UNIVERSAL CONNECTOR - SEE PAGE NO. 4 AND 5



SWING SHAFT

SEE PAGE NO. 18

NEW PRODUCTS



CLIMBING LADDER IN 3 SIZES

SEE PAGE NO. 37



HANGING FRAME FOR TOWERS

SEE PAGE NO. 38



SEESAW SEAT "ERGONOMIC"

SEE PAGE NO. 32



SAFETY SWING SEAT | EXTRA LONG

SEE PAGE NO. 12

BARS & POLES	35 - 41
BASKET BALL RINGS	30
BASKET CHAIR/SPECIAL NEEDS CHAIR	25
BIRD NEST SWING	22 - 24
CABLEWAY SYSTEM	28 - 29
CHAINS AND & EYE NUT	20
CLIMBING LADDER IN 3 SIZES, CURVED DESIGN	37
CRADLE SEAT WITH EYENUT & J-HOOK	14
GRIPS & MONKEY HANDLE	32
GROUP SWING BEARING	27
HANGING FRAME FOR TOWERS	38
HAMMOCK	21
MOUNTING SOCKET	19
PLASTIC COMPONENTS	47
POLE TWISTER	30
POST FOOT – GROUND ANCHOR	43 – 44
UNIVERSAL CONNECTOR	4 – 5
ROPE SWING	15
SAFETY SLABS & SAND BOX UNITS	46
SAND PLAY	34
SEESAW BEARINGS, SOFTENER & SEAT	31 – 32
SECURITY BAR	13
SLIDES	6 – 8
SLIDING POLE & PARALELL MOUNTED	40
SOMERSAULT / FITNESS SYSTEM - FREESTANDING	36
SPIRAL SLIDING TUBE	41
SPRING MOUNTED NEST SWING	25
SURFACING & LAWN MATS	45 – 46
SWING BEAM	10
SWING BEARINGS / FITTINGS	16 – 17
SWING SEATS	11, 12, 15
SWING SHAFT & ACCESSORIES	18 – 19
TRAMPOLINE IN 5 SIZES	42
T - SWING	9
UNIVERSAL JOINT, VERTICAL INSTALLATION	21
TYRE SWING AND HANGAR	15 – 16
SUSPENSIONS FOR NEST SWING	26
GENERAL TERMS	48

NEWS - patent pending...

CONNECTOR

MEETS THE REQUIREMENTS IN EN1176
- NO FINGER TRAPS -



WE ARE PLEASED TO PRESENT THE NEW AND LONG AWAITED UNIVERSAL CONNECTOR. THE CONNECTOR IS DESIGNED FOR GENERAL USE WITHIN THE PLAYGROUND INDUSTRY AS WELL AS OTHER INDUSTRIES.

THE UNIQUE CONSTRUCTION MAKES IT POSSIBLE FOR PLAYGROUND BUILDERS, TO STANDARDISE ON ONE TYPE OF CONNECTION, INSTEAD OF MAKING CASE-BY-CASE SOLUTIONS WITH SHACKLES, EYEBOLTS ETC. IDEAL FOR MOUNTING ON ROUND AS WELL AS FLAT SURFACES

THE MAIN BENEFITS TO CONSIDER WOULD BE:

- ✓ YOU CAN STANDARDISE ON ONE TYPE CONNECTION.
- ✓ INSTALLATION IS QUICK AND SIMPLE
- ✓ AVOID INSTALLERS USING "QUESTIONABLE" SHACKLES & EYEBOLTS
- ✓ COST EFFECTIVE.
- ✓ ALL PARTS IN STAINLESS STEEL

THE HANGAR IS RESTING IN A NYLON-BUSHING MAKING IT ABLE TO REDUCE WEARING.



OUR CONNECTOR IS A 3-PIECE CONSTRUCTION CONSISTING OF:

- 1 HANGAR
- 2 HOUSING,
- 3 CURVED BACKING PLATE

THE CONNECTOR IS MOUNTED USING A M10 OR M12 SQUARE NECK BOLT, (BOLT NOT INCLUDED.)

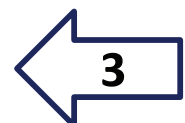
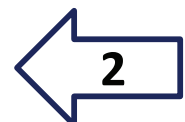
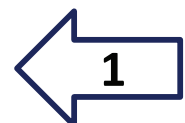

INITIALLY THE CONNECTOR WILL BE AVAILABLE IN THREE SIZES, SUITABLE FOR CHAIN, ROPE OR OTHER POSSIBLE APPLICATIONS



PLEASE CHECK LOAD STRENGTH, WHETHER IT IS SUITED FOR THE PURPOSE OF USAGE

TURNABLE 90 DEGREES

INTRODUCTION PRICES

Art. No.	Quantity/ per Order	Unit Price/£
1258 5 (5mm CHAIN & OTHER CONNECTION)		
	20pcs	5.09
	100pcs	4.52
	200pcs	4.45
	500pcs	4.33
1258 6-10 (6 to 10mm CHAIN & OTHER CONNECTION)		
	20pcs	5.22
	100pcs	4.65
	200pcs	4.58
	500pcs	4.45
1258 13-18 (13-18mm CHAIN & OTHER CONNECTION)		
	20pcs	5.35
	100pcs	4.77
	200pcs	4.71
	500pcs	4.58

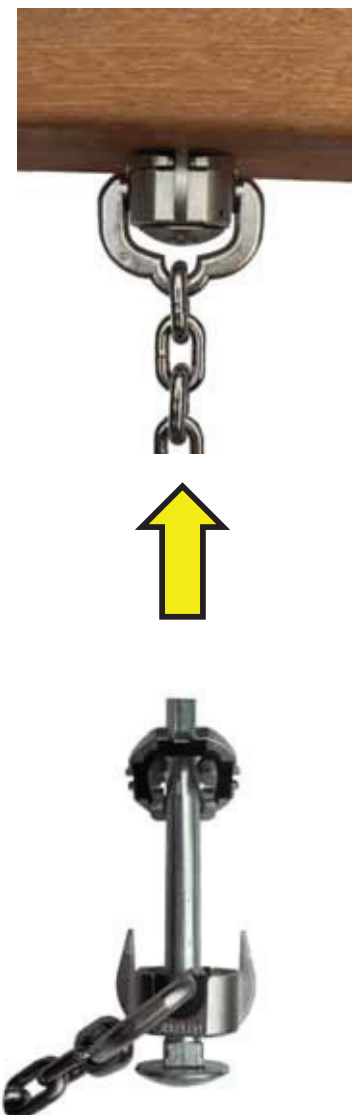

SLIDE FOR TOWER MOUNTING OR AS EMBANKMENT

WIDTH 500MM
 MATERIAL STAINLESS STEEL, AISI 304
 SHEET 2MM
 HANDRAIL 38X2MM
 SECURITY BAR 25MM

Art. No.	Height/mm	Width/mm	Price/£
11090 0900 1000	900-1000	500	897.27
11090 1250 1500	1250-1500	500	1075.45
11090 1750 2000	1750-2000	500	1190.00
11090 2250 2500	2250-2500	500	1344.00



WIDTH 1000MM
 MATERIAL STAINLESS STEEL, AISI 304
 SHEET 2,50MM
 HANDRAIL 38X2MM
 SECURITY BAR 38MM

Art. No.	Height/mm	Width/mm	Price/£
11090 1000 1M	900-1000	1000	1653.00
11090 1500 1M	1250-1500	1000	1923.09
11090 2000 1M	1750-2000	1000	2164.91
11090 2500 1M	*2250-2500	1000	2442.36



* PLEASE NOTE: SLIDES EXCEEDING 2,0 METERS IN HEIGHT
 MEASURED FROM GROUND LEVEL UP TO THE PLATFORM
 CAN NOT BE EASY ACCESSIBLE

SLIDE FOR TOWER MOUNTING WITHOUT UPPER WINGS

MATERIAL	STAINLESS STEEL, AISI304
SHEET	2MM
HANDRAIL	38X2MM
SECURITY BAR	NOT INCLUDED

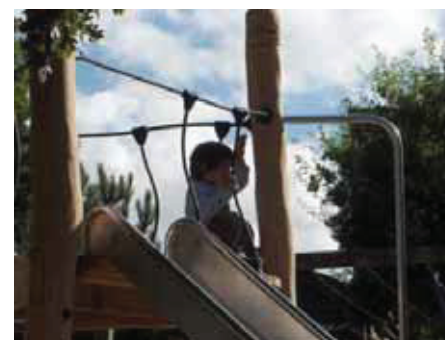

* PLEASE NOTE: SLIDES EXCEEDING 2,0 METERS IN HEIGHT MEASURED FROM GROUND LEVEL UP TO THE PLATFORM CAN NOT BE EASY ACCESSIBLE

Art. No.	Height/mm	Width/mm	Price/£
11050 0600 0700	0600-0700	500	715.27
11050 0750 1000	0900-1000	500	804.36
11050 1250 1500	1250-1500	500	983.82
11050 1750 2000	1750-2000	500	1098.36
11050 2250 2500	*2250-2500	500	1251.09

SLIDE WITH LADDER – FREE STANDING

MATERIAL STAINLESS STEEL, AISI304
 SHEET 2MM
 HANDRAIL 38X2MM
 SECURITY BAR 25mm

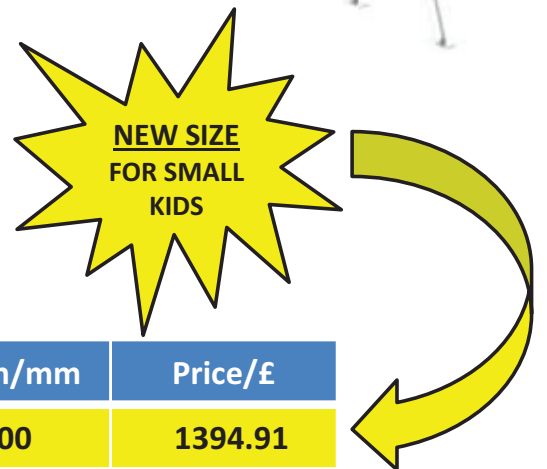

Art. No.	Height/mm	Width/mm	Price/£
11095 0900 1000	900-100	500	1394.91
11095 1250 1500	1250-1500	500	1562.91
11095 1750 2000	1750-2000	500	1691.45

T - SWING

PRE-FABRICATED T-SWING CONSTRUCTION

SOLID CONSTRUCTION MADE OF TWO HEAVY DUTY, HOT DIP GALVANIZED, PARTS.

SWING POINTS ARE INTEGRAL WITH THE TOP SWING BEAM AND SUPPLIED WITH OUR STAINLESS STEEL SWING BEARINGS.

THE CENTER POST IS MADE WITH A BASE PLATE READY FOR CONCRETE FOUNDATION.

SOME OF THE ADVANTAGES WE WOULD LIKE TO HIGHLIGHT:

- VERY COST EFFECTIVE SWING CONSTRUCTION
- STRONG AND HEAVY CONSTRUCTION MAKES THIS SWING SUITABLE FOR AREAS WHERE VANDALISM IS A CONSIDERATION
- ASSEMBLY AND INSTALLATION IS QUICK & EASY
- IDEAL FOR AREAS WHERE SPACE IS LIMITED
- SAFETY AREA IS TYPICAL SMALLER COMPARED WITH TRADITIONAL SWING CONSTRUCTIONS
- PACKAGING OF THE COMPLETE UNIT IS COMPACT (ONLY TWO PARTS)



Art. No.	Description	Price/£
1253 19 A	T-swing	434.00

SWING CROSS BEAM – FOR SWING FRAMES



PRE-FABRICATED UPPER SWING BEAM

BOTH OUR SWING CROSS BEAMS ARE MANUFACTURED IN HOT DIP GALVANIZED STEEL, READY TO ADOPT FOUR WOODEN LEGS (90x90mm)

THE SWING CROSS BEAM IS SUPPLIED WITH STAINLESS STEEL BEARINGS:

EITHER

SWING FITTING ART. NO. 1253
(TO BE USED FOR DOUBLE SWINGS)

OR

UNIVERSAL JOINT ART. NO. 1251 AND
SECURITY FITTING ART. NO. 1257
(TO BE USED FOR BIRD NEST SWINGS)



POSTFOOT / GROUND ANCHOR ARE ADDITIONAL, **PLEASE LOOK FURTHER IN THE CATALOGUE**



Art. No.	Description	Price/£
1253 18	Double swing	268.00

Art. No.	Description	Price/£
1253 19	For Bird Nest	372.91

SAFETY SWING SEAT (SLIM-LINE) SWING SEAT
OF RUBBER COMPOUND WITH ALUMINIUM INSERT.
SIZE: 450 X 160 X 40MM



Art. No.	Colour	Unit Price 1 to19 pcs. /£	Unit Price 20-99pcs. /£
0100	BLACK	15.85	13.87
0101	BLUE	18.84	15.15
0102	RED	18.84	16.42
0103	GREEN	18.84	15.15

PLEASE NOTE:
FOR HIGHER QUANTITIES
CONTACT SALES OFFICE

FOR ALL SWING SEATS:
CHAINS FOR SWING SEATS ARE
NOT INCLUDED. SEE OUR
RANGE OF CHAINS IN OUR
CATALOGUE.

SAFETY SWING SEAT (STANDARD) SWING SEAT
OF RUBBER COMPOUND WITH ALUMINIUM INSERT.
SIZE: 440 X 180 X 40MM



Art. No.	Colour	Price/£
1256 10	BLACK	15.85
1256 RED	RED	18.84
1256 BLUE	BLUE	18.84
1256 GREEN	GREEN	18.84

SAFETY SWING SEAT (EXTRA WIDE)

SWING SEAT OF P.U. COMPOUND

SEAT INSERT: HEAVY DUTY ALUMINIUM SIZE: 435 X 220MM



Art. No.	Colour	Price/£
1265	BLACK	31.95

SAFETY SWING SEAT (EXTRA LONG)

LATEST ADDITION TO OUR SWING SEAT FAMILY
THE "EXTRA LARGE" VERSION OFFERS A **WIDER AND LONGER SEATING SURFACE** IDEAL FOR:

- ✓ CHILDREN WITH SPECIAL NEEDS
- ✓ FOR ADULTS

THE QUALITY IS WELL KNOWN FROM OUR STANDARD SWING SEAT
EN1176 TESTED AND CERTIFIED BY TÜV



EXTRA LONG

STANDARD

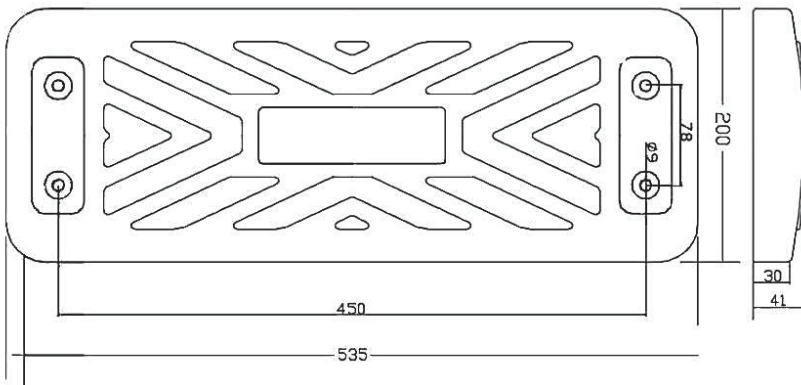

Art. No.	Colour	Price/£
0150	BLACK	33.09

ONE OF THE MARKET'S BIGGEST SWING SEATS, WITH A WEIGHT OF ONLY 1,80 KG → REDUCING THE HIC VALUES, DURING IMPACT TESTING

THE ERGONOMIC SECURITY BAR MATERIALS:

STAINLESS STEEL TUBE
 TUBE PARTIAL COVERED WITH BLACK PU COMPOUND
 CHAIN HOUSING MADE DURABLE PLASTOMER COMPOUND
 SUITABLE FOR 5 & 6 MM CHAIN
 CAN BE MOUNTED ON EXISTING SWING CHAIN WITHOUT
 ANY DISASSEMBLY.



ADVANTAGES ON STANDARD TWO SWING FRAMES:

OFFER YOUR CUSTOMER ADITIONAL OPTIONS
 CONTROL THE JUMP OFF DIRECTION = ADDED SAFETY
 MOUNT THEM SO THAT THE 2 SWINGS DO NOT HAVE THE
 SAME JUMP OFF DIRECTION
 UPGRADE EXISTING SWINGS QUICK AND EASY

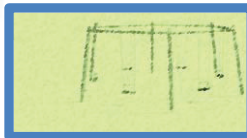

FURTHER APPLICATIONS:

MANDATORY REQUIREMENT AS PER EN 1176
 CONTACT SWINGS / HEXAGON SWING ARRANGEMENT

*On Standard two swing frames, it can advantageous be used to
 achieve opposite jump off direction. The advantage being that you
 achieve an added safety, meaning you avoid that the children jump off
 simultaneous, with the risk of hitting each other.



MOUNTING (takes only 5 minutes)

1. Open the chain housing.
2. Insert chain
3. Close housing
4. Insert the 4 pins (2 each side)
5. Finished



Art.No.	Price£
8500	23.74

CRADLE SEAT / TODDLER SEAT

TODDLER SEAT FOR THE SMALL CHILDREN OR THE PHYSICALLY CHALLENGED

EXCELLENT SOFT GRIPING FOR THE CHILDREN - COMPLETE UNIT SUPPLIED FOR SELF-ASSEMBLY

SIZE AND WEIGHT: 435 X 220 X 258MM – 5.0KG /
SEAT INSERT: UNIT HEAVY DUTY ALUMINIUM

THIS MODEL IS PREPARED FOR OUR SWING CHAINS *



* M8 EYENUTS ARE NOT INCLUDED, BUT CAN BE PURCHASED SEPARATELY: SEE PAGE 19 (ART. 1256 16 : £1.00 PER PIECE)

Art. No.	Colour	Price/£
1264U	3-COLOUR	63.89 *
1264U BLACK	BLACK	74.45*



CRADLE SEAT WITH J-HOOK

TODDLER SEAT FOR THE SMALL CHILDREN OR THE PHYSICALLY CHALLENGED

EXCELLENT SOFT GRIPING FOR THE CHILDREN - COMPLETE UNIT SUPPLIED FOR SELF-ASSEMBLY.

THIS MODEL IS SPECIALLY DESIGNED FOR SWING CHAINS WITHOUT EYENUTS – MEANING THIS IS MOUNTED DIRECTLY TO A CHAINLINK.



Art. No.	Colour	Price/£
1267U	3-COLOUR	63.89

WRAP-AROUND BELT SWING

Rubber wrap around seat consisting of 8 mm thick rubber (640 x 150 mm). Metal fixation plates and galvanised triangle fixation rings.



Art. No.	Colour	Price/£
1256 00	BLACK	32.33

ROPE SWING

SHIP HAWSER WITH SQUARE ROPE (140X140MM) AND STEEL CORE. SUSPENSION IN 2 OR 3 POINTS.



Art. No.	Users	Price/£
7450	1-User	451.82
7455	2-Users	652.91

TYRE SWING WITH CHAIN

Stainless steel hangers mounted on a rubber Tyre. Galvanized supporting washers underneath . The tyre is black in colour. 6mm short-link, stainless steel chain.



Art. No.	Colour	Price/£
1256 09	BLACK	141.27

HANGAR FOR TYRE SWING

Material: 10 mm stainless steel rod,
High-gloss finish. Spare part including:

- Galvanized Washers,
- Stainless steel schackle for connection with chain
- Hole with nylon bushing

Art. No.	Material	Price/£
1256 07	AISI 304	12.79



D-SCHACKLE - UNIVERSAL USAGE

Stainless Steel and with flush bolt.
Size M6.

100 PCS PER CARTON

Art. No.	Material	Price/£
1253 02	AISI 304	174.36



Price per 100 pcs.

SWING FITTING WITH MOUNTING PLATE

Art. No. 1254 01

COMPLETE IN STAINLESS STEEL, WITH ROTATING FORK, FOR
CONNECTION OF THE CHAIN

MOUNTING PLATE WITH 2 HOLES FOR M12 BOLTS



Art.No. 1254 01 – This Swing Fitting is equipped with 2 x ball bearings!

Quantity	Price/£. per pcs.
1-9 pcs	24.42
10-19 pcs	22.27
20-99 pcs	21.00
100-249 pcs	19.73
250+ pcs	CALL OFFICE!

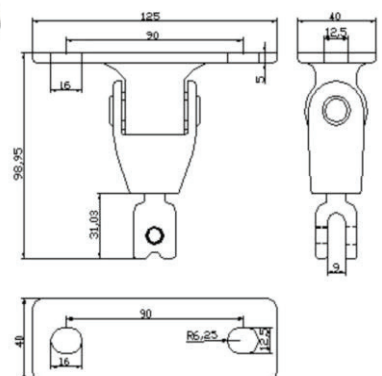

SWING FITTING WITH BOLT

Art. No. 1253

COMPLETE IN STAINLESS STEEL, WITH ROTATING FORK, FOR CONNECTION OF THE CHAIN
M12 STAINLESS STEEL BOLT (NUT EXCLUDED)

**PLEASE CHOOSE FROM BELOW-MENTIONED
STANDARD BOLT LENGTH:
130MM - 135MM – 140MM – 160MM
170MM – 185MM – 200MM**

ALSO AVAILABLE WITHOUT BOLT
POSSIBLE TO WELD DIRECTLY ON STEEL BEAM

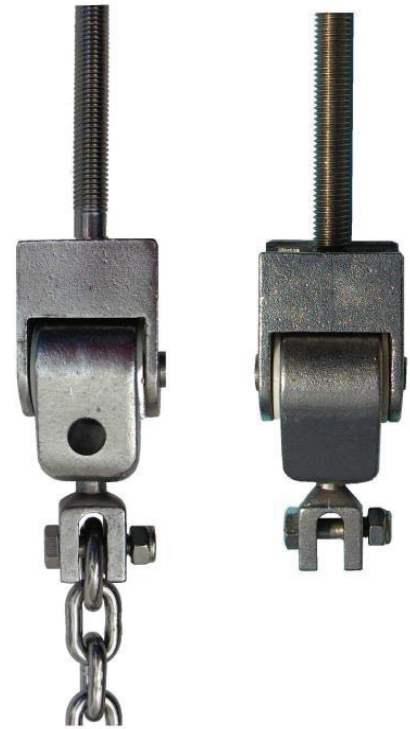

SWING FITTING WITH MOUNTING PLATE

Art. No. 1254

COMPLETE IN STAINLESS STEEL, WITH ROTATING FORK, FOR CONNECTION OF THE CHAIN
MOUNTING PLATE WITH 2 HOLES FOR M12 BOLTS



PRICES APPLICABLE FOR BOTH
MODELS 1253 AND 1254

Quantity	Price/£ per pcs
1-19pcs	17.31
20-49pcs	15.85
50-99pcs	13.49
100-199pcs	13.24
200-499pcs	13.11
500-999pcs	12.98
1000 and up	12.85



SWING SHAFT WITH ROTATING FORK

COMPLETE IN STAINLESS STEEL, Ø15 AXLE. AND HEAVY DUTY BALL BEARINGS - 2PCS STAINLESS STEEL M16 BOLTS, WIDTH FROM 300MM to 800MM BOLT LENGTH TO BE SPECIFIED ON EACH ORDER.

IDEAL TO USE WITH OUR RANGE OF:

CHILDREN REQUIRING EXTRA ATTENTION:

- ✓ SWING SEATS : "EXTRA LARGE"
- ✓ BASKET CHAIR

SINGLE- / MULTIPLE-USER SWING FRAMES:

- ✓ CONTACT SWING WITH UP TO 6 USERS
- ✓ STANDARD SWING FRAMES

NOT SUITABLE FOR BIRD NEST SWING

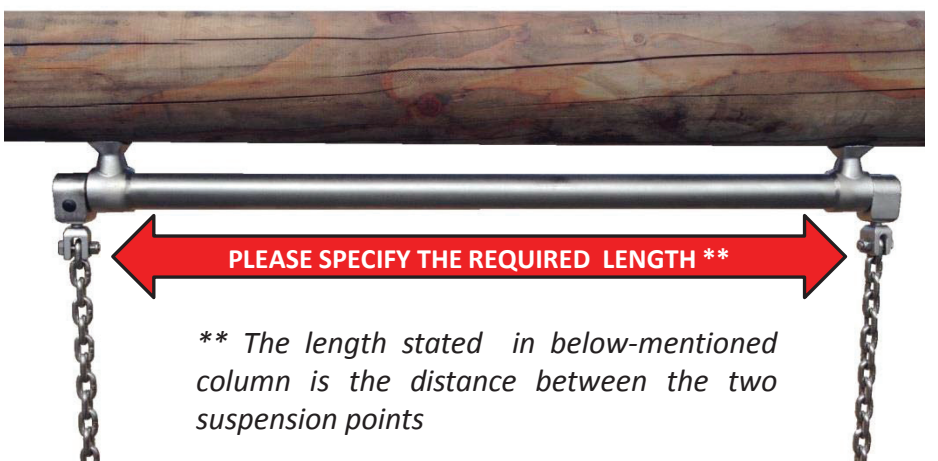

*** The length stated in below-mentioned column is the distance between the two suspension points*

Art. No.	Length /mm	Qty. 1pcs	Qty. 2-5pcs	Qty. 5pcs +
1250 V1	300-500	108.18	100.55	90.36
1250 V1	500-800	142.55	132.36	118.36

SWING SHAFT WITH ROTATING FORK

COMPLETE IN STAINLESS STEEL, Ø20 AXLE.
BALL BEARINGS 2PCS STAINLESS STEEL M16
BOLTS, WIDTH FROM 300MM to 3000MM
BOLT LENGTH TO BE SPECIFIED ON ORDER.

Art. No.	Length/mm	Price/£
1250	300-500	120.91
<i>The length stated in the next column is the distance between the two suspension points</i>	650-800	147.64
	1000-1200	180.73
	1500-2000	235.45
	2000-3000	263.45

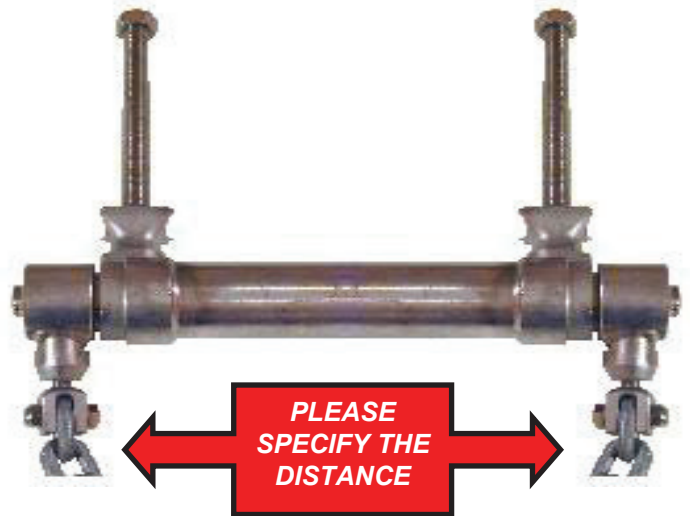

Not suitable for Bird Nest Swing

MOUNTING SOCKET / SLEEVE

STAINLESS STEEL AISI 304, SUITABLE FOR CONNECTION WITH ALL SWING TYPES M10 - M12 - M16

Min. Qty. Per Order	Art. No. 1372 20 M10 x 20mm	Art. No. 1372 M10 x 40mm	Art. No. 1370 M12 x 50mm	Art. No. 1371 M16 x 50mm
50pcs	3.05/per pcs	3.69/per pcs	4.20/per pcs	4.84/per pcs
100pcs	2.55/per pcs	3.12/per pcs	3.63/per pcs	4.07/per pcs
250pcs	2.23/per pcs	2.67/per pcs	3.05/per pcs	3.50/per pcs
400pcs +	1.53/per pcs	2.29/per pcs	2.55/per pcs	3.05/per pcs

Art. No. 1370 T50 : 1packet Incl. 5pcs of Torx50 Bits, 17.69/packet



MOUNTING SET, SWING FITTINGS

SPARE PART, M8 BOLT AND SELF-LOCKING NUT

Art. No.	Length/mm	Price/€
1257 0830	M8x30	0.76
1257 0834	M8x34	0.76

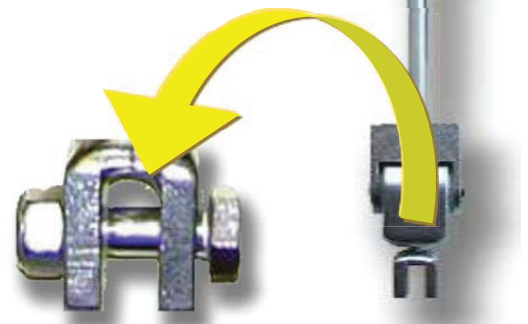

SWING CHAINS

SHORT-LINK DIN766 WITH CROW FOOT FEMALE M8 EYE NUT FOR CONNECTION. WITH MOST SEATS AVAILABLE IN THE MARKET



5MM CHAIN, STAINLESS STEEL AISI304

Length/M	Art. No.	Price/£
1,80	1256 11	13.62
2,00	1256 12	14.64

STRAIGHT CHAIN, BUNDELS OF 50M

Size	Art. No.	Price/£
>> STAINLESS STEEL AISI 304 <<		
5mm	1256 21	285.09
6mm	1256 22	372.91
>> HOT DIP GALVANIZED <<		
50m	1256 17	193.45
100m	1256 17 x 2	350.00
200m	1256 17 x 4	656.73
500m	1256 17 x 10	1459.82

6MM CHAIN, HOT DIP GALVANIZED

Length/M	Art. No.	Price/£
1,80	1256 08	9.23
2,00	1256 01	10.05
2,20	1256 02	10.69

6MM CHAIN, STAINLESS STEEL AISI304

Length/M	Art. No.	Price/£
1,80	1256 18	19.73
2,00	1256 19	21.00
2,20	1256 20	23.04

EYE NUT M8 (FEMALE)

STAINLESS STEEL AISI 304, WITH WINGS

Art. No.	Price/£
1256 16	1.27



UNIVERSAL JOINTS FOR VERTICAL INSTALLATION

COMPLETE STAINLESS STEEL, HEAVY DUTY NYLON BUSHING WITH TAMPER-PROOF RIVETTING, ROTATABLE FORK, AND M8 BOLT AND SELF LOCKING NUT FOR CONNECTION WITH CHAIN

1701 WITH M16 BOLT



REGARDING ART. NO. 1701, THE STANDARD BOLT LENGTH IS 200MM.

FOR CUSTOMIZED LENGTHS, PLEASE SPECIFY ON ORDER

PRICES APPLICABLE FOR BOTH MODELS OF **VERTICAL MOUNTING**: Art. No. 1701 (with M16 Threaded Bolt) & Art. No. 1751 (with plate)

Quantity	Art. No.	Price/£per pcs
2pcs	1701 or 1751	46.71
4pcs	1701 or 1751	45.82
10pcs	1701 or 1751	37.55
30pcs	1701 or 1751	33.41
50pcs	1701 or 1751	31.50
100pcs	1701 or 1751	29.91
200pcs	1701 or 1751	28.95

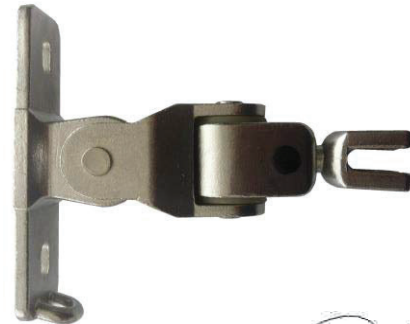

1751 WITH MOUNTING PLATE

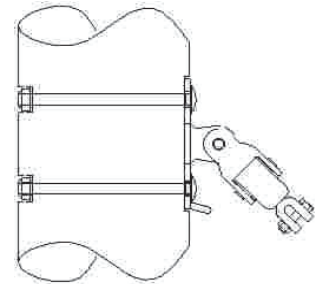

HAMMOCK

ROPE: 16MM WITH STEEL STRANDS
 DIMENSION: 2000 X 1000mm
 MESH SIZE: 100 X 100mm

PLEASE NOTE!

When installed, the center part of the hammock should be suspended minimum 400mm above ground level
 Price excluding the universal joints for suspension. (Art.No. 1701 or 1751)

Colour	Art. No.	Price £
Black	1253 17	632.55

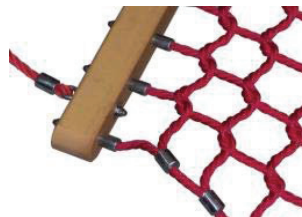

BIRD NEST SWING (2-POINT SUSPENSION)

GROUP SWING FOR MULTIPLE USERS, THE PRODUCT CONSISTS OF A STEEL RING COVERED WITH A CUSHIONING MEMBRANE.

ROPE: 16MM USACORD LONG-LIFE WITH STEEL THREADS

SIZE: Ø1000 AND 1200MM IN DIAMETER

2-POINT SUSPENSION, STANDARD AVAILABLE FROM STOCK.

ALTERNATIVE - 4-POINT SUSPENSION (SEE NEXT PAGE)

Ø 1000MM

Colour	Art. No.	Price/£
BLACK	1253 08	524.36
BLUE/RED	1253 09	524.36

Ø 1200MM

Colour	Art. No.	Price/£
BLACK	1253 05	585.45
BLUE/RED	1253 06	585.45
BLACK/GREEN	1253 11	585.45



Ø 1450MM

Colour	Art. No.	Price/ £
BLACK	7300	1058.91
BLUE/RED	7305	1058.91



BIRD NEST SWING (2-POINT SUSPENSION)

SPECIALIZED COLOUR RANGE

GROUP SWING FOR MULTIPLE USERS, THE PRODUCT CONSISTS OF A STEEL RING COVERED WITH A CUSHIONING MEMBRANE.

ROPE: 16MM USACORD LONG-LIFE WITH STEEL THREADS

SIZE: THIS COLOUR COMBINATION ONLY AVAILABLE IN Ø 1200MM

WE RECOMMEND THAT THE NET IN THE CENTER AND THE SUSPENSION ROPES ARE ALWAYS KEPT IN BLACK COLOUR.



Ø 1200MM		SPECIALIZED COLOURS
Colours	Art. No.	Price/£
BLACK/BLUE	7045	670.73
BLACK/RED	7046	670.73
BLACK/GREEN	7047	670.73

SPECIAL VERSIONS OF BIRD NEST SWING

GROUP SWING FOR MULTIPLE USERS
PRODUCT CONSISTS OF A STEEL RING COVERED WITH A CUSHIONING MEMBRANE.

ROPE: 16MM USACORD LONG-LIFE WITH STEEL THREADS

SIZE : Ø1000 OG 1200MM

Ø 1000MM, 4-POINT SUSPENSION		
Colour	Art. No.	Price/ £
BLACK	1253 08 4P	613.45
BLUE/RED	1253 09 4P	613.45

Ø 1200MM, 4-POINT SUSPENSION		
Colour	Art. No.	Price/ £
BLACK	1253 05 4P	674.55
BLUE/RED	1253 06 4P	674.55



BIRD NEST SWING WITH FINE MESH (2-POINT SUSPENSION)

THE SEATING AREA OF THIS FINE-MESH MODEL OF BIRDS NEST SWING PROVIDES CONSIDERABLE SMALLER MESH SIZES, A HIGHER NUMBER OF CONNECTION LINKS BETWEEN NET AND RING. SPECIFICALLY DESIGNED FOR YOUNGER CHILDREN.



Ø 1200MM, >> FINE MESH <<		
Colour	Art. No.	Price/£
BLACK	1253 05K	731.82
BLUE/RED	1253 06K	731.82
MULTI	1253 MULTI-K	731.82



BIRD NEST SWING "SOFT TOUCH"

(2-POINT SUSPENSION)

SUITABLE FOR INDOOR USE FOR THE SMALL CHILDREN. RING IN PLASTIC WITH EXTRA SHOCK ABSORBING MATERIAL, WHICH ENSURES A LOW HIC-VALUE <50g.

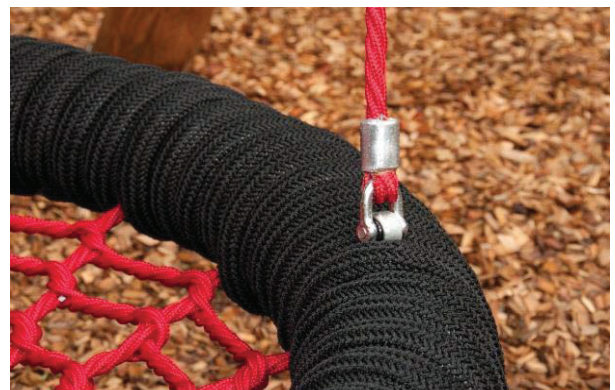

Ø 1200MM, >> SOFT TOUCH <<		
Colour	Art. No.	Price/£
BLACK/RED	7365	1323.64

BASKET CHAIR | SPECIAL NEEDS CHAIR

SWING IN THE SHAPE OF A BASKET CHAIR WITH EXTRA SUPPORT.

WE RECOMMEND ART. NO 1251 OR 1252 FOR SUSPENSION.

FRAME: GALVANIZED, WITH SHOCK ABSORBANT MATERIAL AND WITH 16MM ROPE WITH STEEL THREADS

ROPE: 16MM ROPE WITH STEEL THREADS



Colour	Art. No.	Price/£
BLACK	7400	819.64
BLUE/BLACK	7425	819.64

SPRING MOUNTED BIRD NEST SWING

THIS FLEXIBLE BIRD NEST SWING IS PRE-ASSEMBLED , READY FOR INSTALLATION THE HEIGHT OF THE COMPLETE PRODUCT INCL. CONCRETING FRAME IS 1300MM, ACHIEVING A FINISHED HEIGHT OF 700MM AFTER INSTALLATION.

ROPE: 16MM USACORD LONG-LIFE WITH STEEL THREADS

SIZE: Ø 1200MM - SPRINGS: 3 PCS, WITH POWDER COATED SURFACE

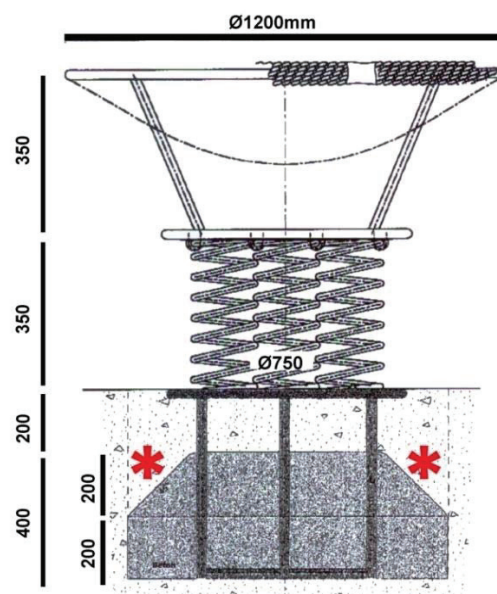

Colour	Art. No.	Price/£
BLACK	1253 14 Black	1686.36
BLUE/RED	1253 14 Blue/red	1686.36

3 POWDER COATED SPRINGS

SUSPENSIONS FOR BIRD NEST SWINGS

COMPLETE STAINLESS STEEL, HEAVY DUTY
 NYLON BUSHING WITH TAMPER-PROOF RIVETTING,
 ROTATABLE FORK, AND M8 BOLT AND SELF LOCKING
 NUT FOR CONNECTION WITH CHAIN

**REGARDING ART. NO. 1251 AND 1257, THE STANDARD
 BOLT LENGTHS ARE 135MM AND 200MM.**

FOR CUSTOMIZED LENGTHS, PLEASE SPECIFY ON ORDER

PRICES APPLICABLE FOR BOTH MODELS 1251 & 1252

Quantity	Art. No.	Price/£ per pcs
2pcs	1251 or 1252	46.71
4pcs	1251 or 1252	45.82
10pcs	1251 or 1252	37.55
30pcs	1251 or 1252	33.41
50pcs	1251 or 1252	31.50
100pcs	1251 or 1252	29.91
200pcs	1251 or 1252	28.95

SECURITY CHAIN WITH D-SCHACKLES

6MM STAINLESS STEEL CHAIN, AND SCHACKLES
 IN BOTH ENDS.

Art. No.	Chains length	Price/£
1252 20	250 MM	5.09

SECURITY BOLT (TO BE USED TOGETHER WITH 1251)

M16 BOLT INCLUDING M8 CHAIN AND HOSE

SECURITY BOLT Art. No. 1257

Art. No.	Bolt length	Price/£
1257	135mm or 200mm	21.64
1257	201mm to 300mm	24.18

ATTENTION: WHEN USED AS A MULTIPLE-USER SWING,
 WE ALWAYS RECOMMEND TO INSTALL A SAFETY CHAIN.

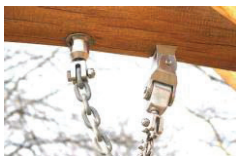

Remember to follow the instructions stated in EN1176

1251
 WITH
 M16 BOLT

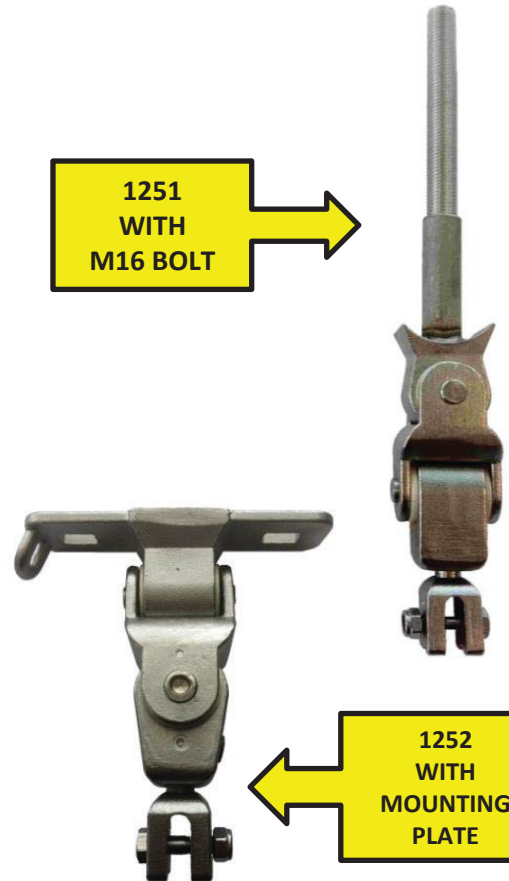

1252
 WITH
 MOUNTING
 PLATE



1252 20
 SECURITY
 CHAIN

1257
 WITH
 M16 BOLT



GROUP SWING BEARING

- Below-mentioned products may not be used together with tyres

THE STAINLESS STEEL GROUP SWING BEARING IS EXTREMELY HEAVY DUTY . IT COMES WITH M6 SAFETY CHAIN, NIPPLE FOR LUBRICATION AND 5PCS OF BALL BEARINGS, 2PCS OF THRUST BEARINGS.

FURTHERMORE 2PCS OF M16 STAINLESS STEEL BOLTS WITH SELF LOCKING NUTS.

Art. No	Mounting	Price/£
1230	Diagonal	213.82
1231	Horizontal	213.82

**BOTH MODELS ARE
FOR 4 - POINT
SUSPENSION**



1230



1231

CABLEWAY SYSTEM – COMPONENTS

CABLEWAY TROLLEY WITH BRAKING SYSTEM
 BUILT IN BRAKING SYSTEM* AND FINGER
 PROTECTION. BODY MADE FROM
 STAINLESS STEEL PLATE (AISI 304).
 NYLON WHEELS WITH BUILT IN BALL BEARINGS
 SUITABLE FOR 10MM CABLE.

*THE BRAKES IS A WEARING PART WHICH
 SHOULD BE REPLACED REGULARLY

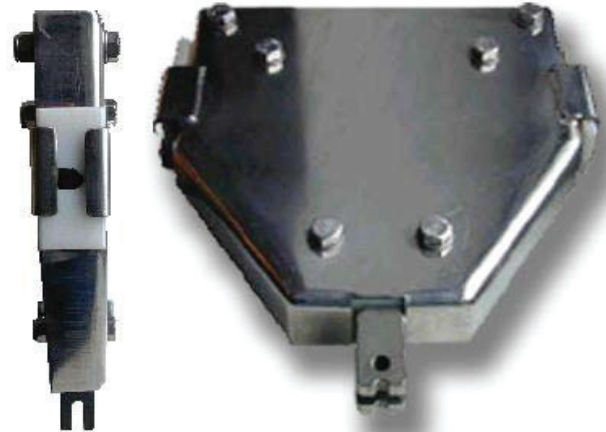

Art. No.	Description	Price/£
1240	Trolley	124.09
1240 01	Brake, spare part	15.27



PENDULUM SEAT WITH M8 HOT DIP GALVANIZED
 STEEL CHAIN AND PROTECTION HOSE LENGTH

Art. No.	Description	Price/£
1245 04	L = 1800MM	48.68
1245 10	L = 2000MM	51.55
1245 10 01	Seat (Spare part)	32.45

BRAKE SPRINGS WITH RUBBER BUFFER
 APPLICATION AS FOLLOWS:

STARTING SECTION: 1 X 1500MM
 RUN-OUT SECTION: 1 X 3000MM

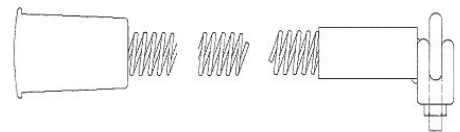

Art. No.	Description	Price/£
1248 1500	L = 1500mm	32.45
1248 3000	L = 3000mm	41.62

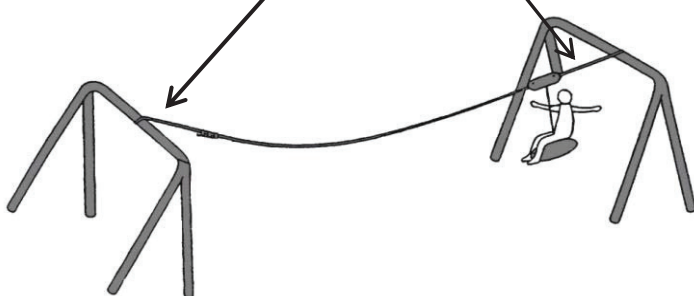

CABLEWAY SYSTEM – COMPONENTS

COUNTER PART CONNECTING WITH THE CABLE.
FOR ROUND OR PLANE BEAMS, BOLTS NOT INCLUDED

Art. No.	Description	Price/£
1247	Round Beam	19.73
1247 01	Square Beam	19.73

CABLE TENSION ADJUSTER WITH RACHET WHEEL
STAINLESS STEEL AISI 304
SUITABLE FOR SYSTEMS UP TO 40 METERS

Art. No.	Description	Price/£
1241	Round Ø180	112.00
1241 01	Round Ø160	112.00
1241 02	Round Ø140	112.00
1241 03	Flat surface	112.00

CABLE TENSION ADJUSTER WITH TOOTHED WHEEL
STAINLESS STEEL AISI 304
SUITABLE FOR SYSTEMS UP TO 50 METERS

Art. No.	Description	Price/£
1242	Round Ø160	138.73
1243	Round Ø180	138.73
1243 02	Round Ø200	138.73
1243 01	Flat surface	138.73

CABLE - GALV. 19X7, 10MM WITH THIMBLE

Art. No.	Description	Price/£
1247 2100	21 Meter	76.36
1247 2500	25 Meter	89.41
1247 3100	31 Meter	105.64
1247 4100	41 Meter	136.18
1247 5100	51 Meter	164.82

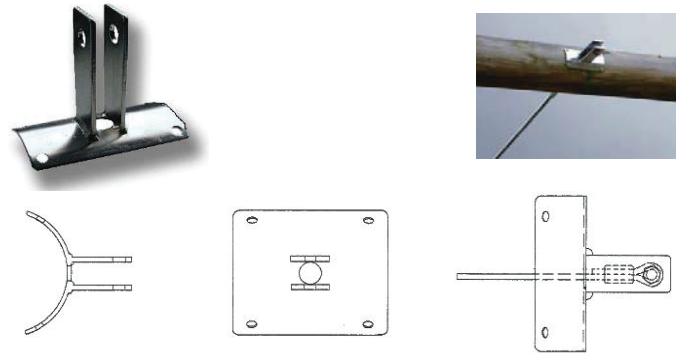

1241

1241 03

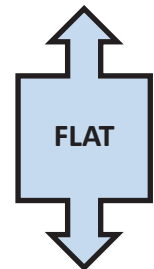

1242

1243 01



BASKETBALL RINGS

WITH CHAIN – VANDALISM PROOF, HEAVY DUTY, SUITABLE FOR THE URBAN ENVIROMENT , STREET BASKET AVAILABLE IN BELOW-MENTIONED VERSIONS

MATERIALS AVAILABLE:
STAINLESS STEEL AISI 304 OR HOT DIP GALVANIZED
CHAIN NET IS MADE FROM THE SAME MATERIAL AS THE BASKETBALL RING.

Art. No.	Material	Details	Price/£
1110	Stainless Steel	With net	109.45
1110 G	Galvanized	With net	75.09
1110 G-CH	Galvanized	No net	60.45



POLE TWISTER

COMPLETE IN CASTING MATERIAL, INCLUDING MOUNTING PLATE.

QUICK AND EASY INSTALLATION, 2 BALL BEARINGS ON EACH SIDE (COMPLETE SET / LEFT & RIGHT SIDE)

- IDEAL FOR LOW LEVEL TRIM TRAILS
- MOUNTING CENTRIC OR CON-CENTRIC WITH THE LATERAL WOODEN BEAM.

Art. No.	Material	Details	Price/£
1262	Stainless Steel	Left/Right	109.45

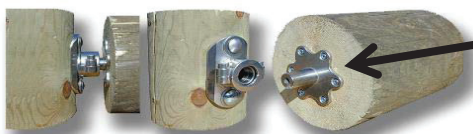

SEESAW EQUIPMENT

SEESAW BEARING FOR MOUNTING BETWEEN 2 POSTS HEAVY DUTY TUBING WITH 4PCS OF BALL BEARINGS

Art. No.	Material	Price/£
1150	Stainless Steel	83.05



SEESAW BEARING WITHOUT ABSORPTION QUICK MOUNTING CONCRETE INTO GROUND, CASTING WELDED ONTO TUBE 120X120X3MM. HOUSING INCLUDING 4 BALL BEARINGS HIGHLY DURABLE.

Art. No.	Material	Price/£
1160	Stainless Steel	211.27
1160 G	Galvanized	124.73



SEESAW BEARING WITH ABSORPTION

QUICK MOUNTING CONCRETE INTO GROUND, CASTING WELDED ONTO TUBE 120X120X3MM. HOUSING INCLUDING 4 BALL BEARINGS HIGHLY DURABLE. MINIMIZED RISK OF INJURY. PAY SPECIAL ATTENTION TO THE MOUNTING INSTRUCTION WHICH IS SUPPLIED WITH THE PRODUCT

Art. No.	Material	Price/£
1170	Stainless Steel	439.09



SEESAW SOFTENER FOR ALL SEESAWS RUBBER GRANULATE TOP PART, FITTED WITH GALVANIZED STEEL TUBING Ø48,3MM

Art. No.	Material	Price/£
1155	Rubber comp.	42.64

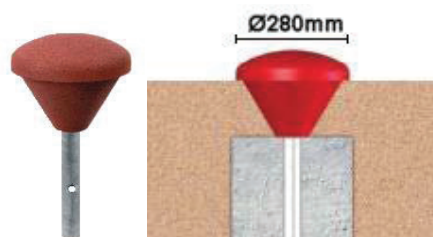

SEESAW SEAT "ERGONOMIC" | N E W S

A BRAND NEW ADDITION TO OUR RANGE OF SEESAW COMPONENTS.

THE NEW **SEESAW SEAT** IS ERGONOMIC AND HAS A SOFT SEATING SURFACE WHICH PROVIDES A LEVEL OF **COMFORT AND SAFETY**

FOR THE CHILDREN REDUCING THE RISC OF SLIDING OFF THE SEAT WHEN IN MOTION

WITH ITS REINFORCED STEEL INSERT THE SEESAW SEAT IS DURABLE AND RESISTANT

PROPERTIES

- ✓ SUITABLE FOR ROUND- AND SQUARE SURFACES
- ✓ FIXATION WITH 3 BOLTS (LOWERED INTO SEAT SURFACE)
- ✓ BUILT-IN DRAINAGE CHANNELS FOR WATER BUILD-UP AT THE REAR BOLTS HEADS
- ✓ COMPANY LOGO ON THE SEAT, ON REQUEST

TECHNICAL DETAILS

LENGTH: 330 MM
 WIDTH: 250 MM
 REINFORCEMENT: STEEL INSERT
 MATERIAL: SOFT & DURABLE COMPOUND
 COLORS: **BLACK (STANDARD) | RED | BLUE + £ 1.00**

NO SKIN BURNING IN THE HOT SUMMER
NO SKIN CONTACT WITH THE BOLT HEADS

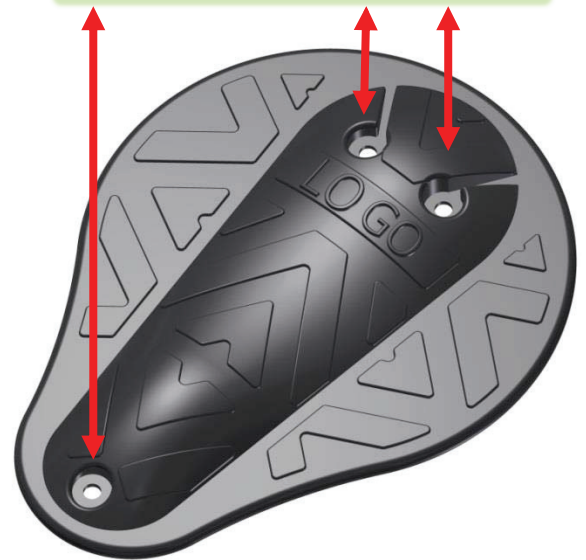

ROUND WOOD



SQUARE WOOD



Art. No.	Qty. 1-9pcs	Qty. 10 -50pcs (sold in boxes of 10 pcs)
1145	19.09/pcs	12.73/pcs

SEESAW GRIPS

SEESAW GRIPS OR FOR HANGING PURPOSE
TUBE Ø25MM WITH 4MM PLATE WHICH IS
ROUNDED TO FIT DIFFERENT BEAMS



Art. No.	Size / mm	Price/£
1180	Ø 140	17.50
1181	Ø 160	17.50
1182	Ø 180	17.50



SEESAW GRIPS OR FOR HANGING PURPOSE
TUBE Ø25MM WITH 4MM PLATE INTENDED
FOR SQUARE BEAMS

Art. No.	Size	Price/£
1190	Flat surfaces	17.50



MONKEY HANDLE, CHAIN & BOLT

ALL PARTS IN STAINLESS STEEL.

HANDLE PARTIALLY COVERED WITH A RED
RUBBER COMPOUND.

Art. No. 1187 04 135

Quantity	Bolt Length	Price/£
1-49pcs	135mm	21.32
50-199pcs	135mm	21.00
200 +	135mm	19.41



SAND PLAY

SAND CRANE PULLY SYSTEM INCLUDING NYLON WHEELS AND BALL BEARINGS. NYLON BUSHING AS CHAIN GUIDE COMPLETE IN STAINLESS STEEL AISI 304 APPLICATION: FOR ROPE OR 5-6MM CHAIN MOUNTING PLATE: SEE BELOW

Art. No.	Mounting	Price/£
1132	Rear (standard)	48.36
1133	Side	55.24
8003	Top	55.24

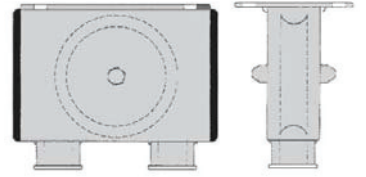

SAND BUCKET

FITS ALL OUR SAND CRANES RUBBER BUCKET WITH STEEL INSERT WITH 4MM STAINLESS STEEL CHAIN DIAMETER Ø180MM.

Art. No.	Size	Price/£
1126 01	With chain	19.41

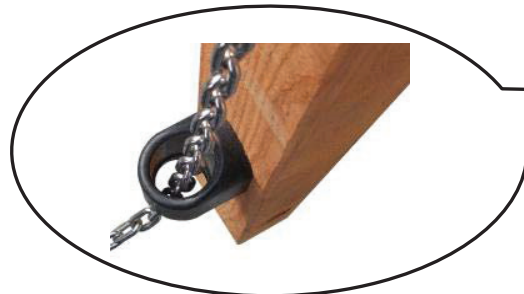

CHAIN GUIDE

STRONG NYLON COMPOUND SOLUTION EASY TO INSTALL, NO FINGER TRAPS, COLOR MATCH WITH SAND BUCKET

Art. No.	Colour	Price/£
1130	Black	8.72

SAND & WATER WHEEL

STAINLESS STEEL WITH BALL BEARINGS MOUNTING TYPE: DIAGONAL OR STRAIGHT

Art. No.	Mounting	Price/£
1140	Diagonal	55.24
1141	Straight	55.24

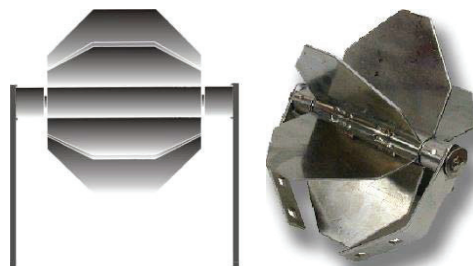

STAINLESS STEEL TUBE SOLUTIONS

FIREMAN POLE

38x2MM TUBE WITH TWO MOUNTING PLATES WELDED. THE MOUNTING PLATES HAS TWO SQUARE HOLES FOR FIXING.

Art. No.	Height	Price/£
1300 3000	3000mm	106.00
1300 4000	4000mm	126.00

FOR SHORTER VERSIONS WE CHARGE £12.00 PER UNIT FOR CUTTING AND RE-WELDING

EXAMPLE:

A HEIGHT OF 2500MM: (106+12) = £118

A HEIGHT OF 3100MM: (126+12) = £138



CLIMBING ROD

38x2MM TUBE, MOUNTING PLATE 40x140MM
SEE OUR STANDARD LENGTHS BELOW:

Price per piece (£)			
Art. No.	Length	Qty. 1-4pcs	Qty. 5-50pcs
1260 800	800mm	25.27	22.59
1260 900	900mm	25.27	22.59
1260 1000	1000mm	27.36	24.18
1260 1200	1200mm	30.86	27.36
1260 1350	1350mm	33.73	29.91
1260 1500	1500mm	41.05	36.91

FOR SHORTER VERSIONS OF THE CLIMBING ROD , WE CHARGE £12.00 PER UNIT FOR CUTTING AND RE-WELDING.

THREADED BARS

MATERIAL STAINLESS STEEL A2

Art. No.	Size	Price/£
1253 M12	M12x2000MM	29.27
1253 M16	M16x2000MM	40.41

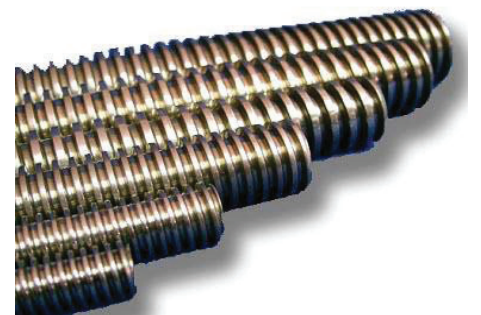

SOMERSAULT ARRANGEMENT FITNESS PUSH-UP BAR

I FREE-STANDING UNIT I

- ✓ QUICK AND EASY MOUNTING.
- ✓ THE 3 PIECES ARE EASILY CONNECTED.
- ✓ NO ADDITIONAL FASTENERS NEEDED.
- ✓ STRAIGHT OR ZIG-ZAG MOUNTING FORMATION.
- ✓ FLAT-PACK SOLUTION ALLOWING LOWER TRANSPORT COST.

MATERIAL: STAINLESS STEEL AISI 304

TUBE: Ø 38 X 2MM

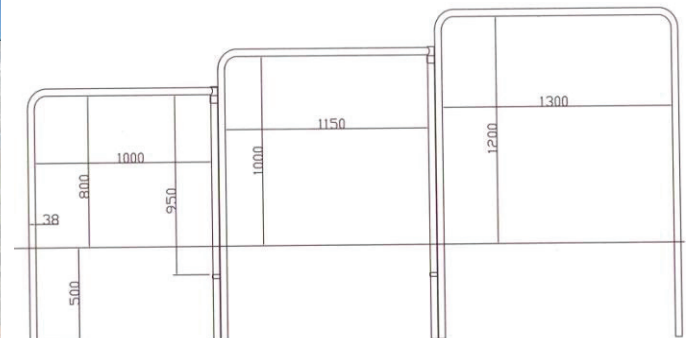
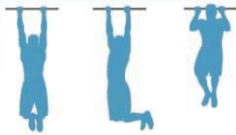

Art. Nr.	Quantity	Price/£
1261	1 Complete unit	273.64

CURVED CLIMBING LADDER

COMPLETE STAINLESS STEEL SOLUTION AISI 304.
HIGHLY DURABLE COMPARED TO WOODEN LADDERS.

MANUFACTURED TO SUIT TOWERS IN DIFFERENT HEIGHTS
PLEASE SEE THE CHART BELOW.

ARTISTIC AND GEOMETRICAL LOOK AS WELL AS THE
TECHNICAL FLEXIBILITY THAT ENSURES QUICK AND EASY
INSTALLATION.

UNIQUE INSTALLATION FITTINGS

STAINLESS STEEL FLANGE AND AXLE THAT ALLOWS THE
WHOLE LADDER TO ROTATE AROUND THE AXLE, THUS
ALLOWING FOR ADJUSTMENT TO SUIT EACH TOWER

INDIVIDUALLY, A BIG **+POINT** FOR THE
INSTALLATION CREW.

CURVED TUBE : Ø 38 X 2MM

CURVED STEPS : Ø 30 X 2MM



**QUICK
FIXASATION**

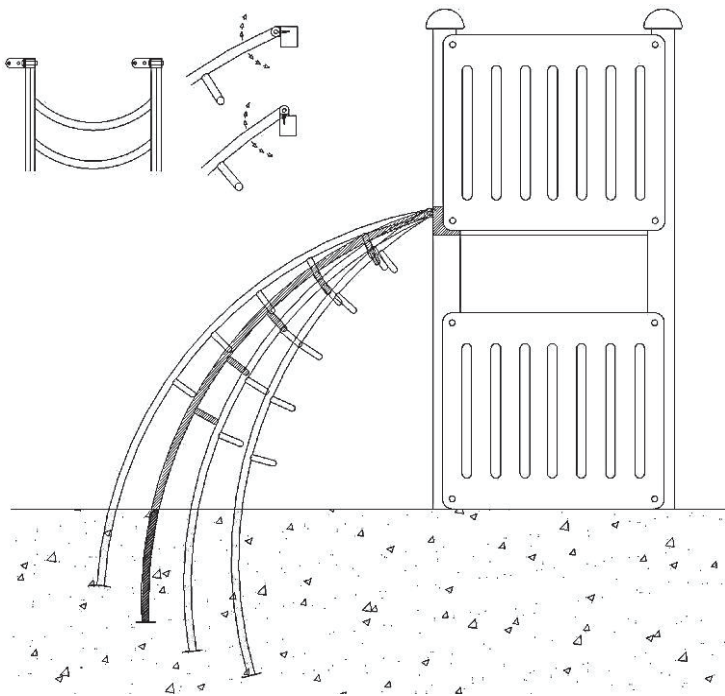
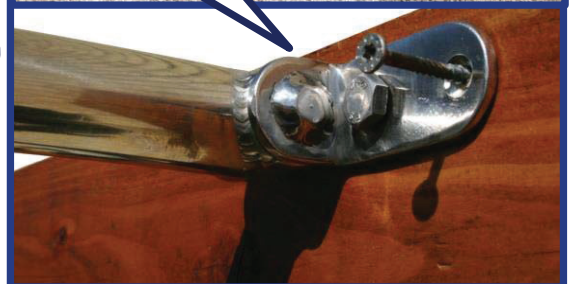

Art. No.	Height	Price/£
5400 100	100 CM	206.18
5400 150	150 CM	257.09
5400 200	200 CM	311.82

HANGING FRAME FOR TOWERS

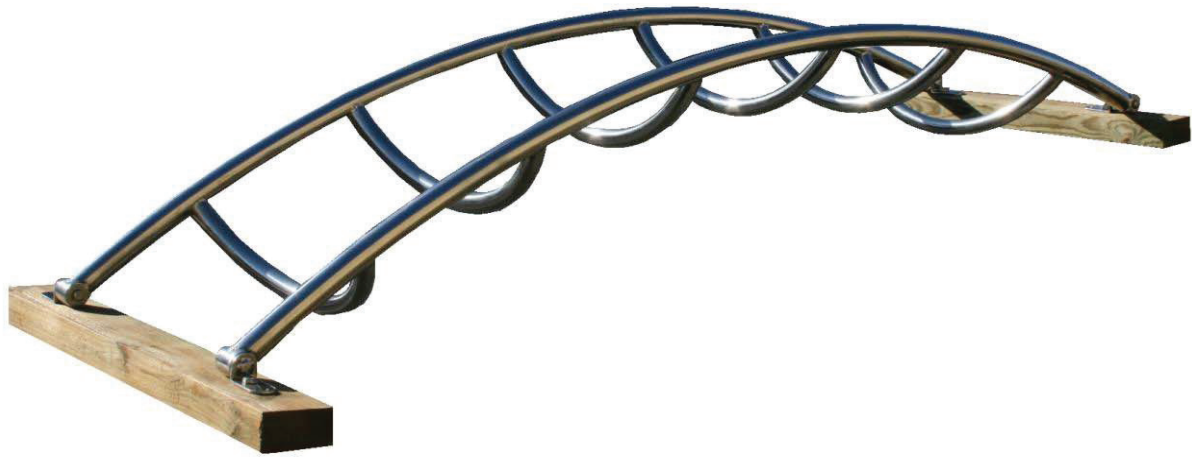

THE COMPLETE STAINLESS STEEL HANGING FRAME IS A READY-TO-USE PRODUCT THAT CAN BE MOUNTED DIRECTLY BETWEEN 2 TOWERS, EVEN **TOWERS IN DIFFERENT HEIGHTS**. THE MOUNTING FIXINGS ARE ADJUSTABLE ALLOWING FOR ADJUSTMENT TO SUIT EACH TOWER INDIVIDUALLY, A BIG **+POINT** FOR THE INSTALLATION CREW. THE FIXINGS CAN BE MOUNTED FROM THE INSIDE OR FROM THE OUTSIDE.

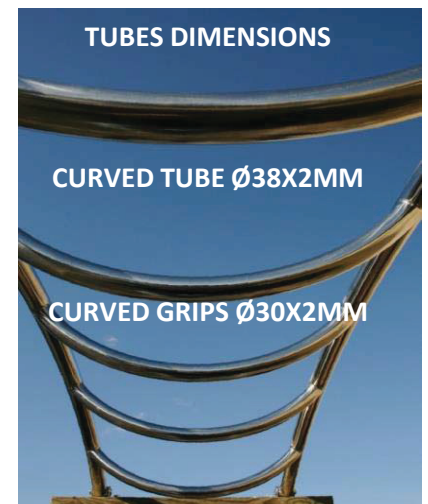
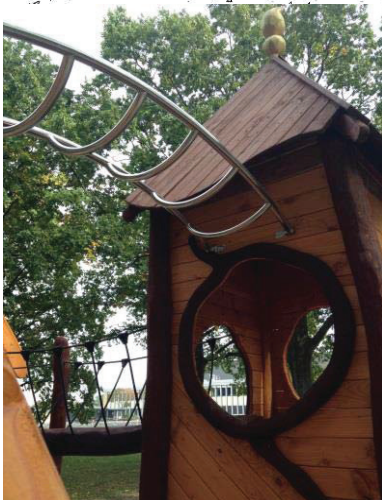
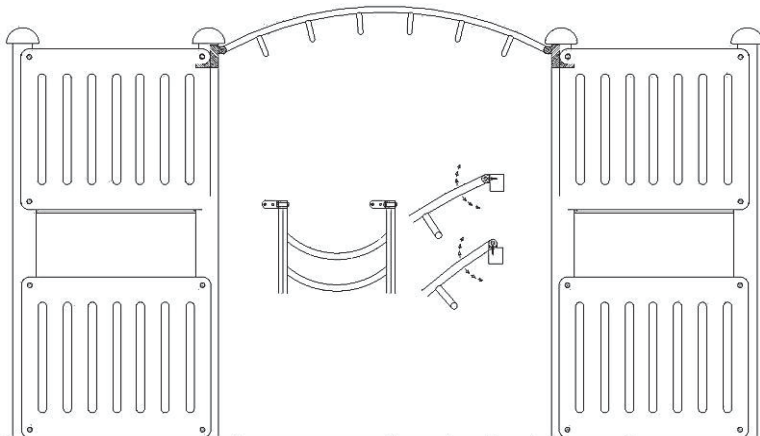

Art. No.	Width	Price/£
5410 200	200 CM	324.55

FIREMAN POLE WITH ROUND ARCH

MATERIAL: STAINLESS STEEL AISI 304
 TUBING: 38X2MM, TOTAL LENGTH 3500MM

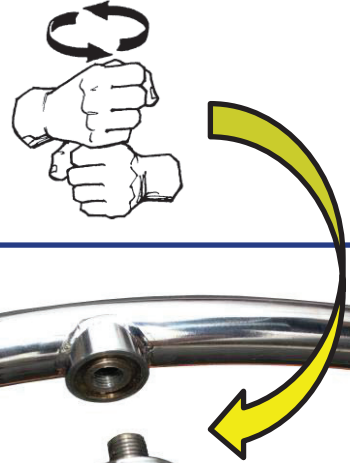

FIREMAN POLE WITH ROUND ARCH AND MOUNTING PLATES.

ENHANCED STABILITY WITH TWO MOUNTING PLATES AT THE UPPER PART.

THE TWO PARTS ARE JOINED TOGETHER USING A SIMPLE BUT VERY STRONG AND UNIQUE CENTRIC RING SYSTEM WITH A M16 THREADED CENTERPIECE



THIS MODEL IS A 2-PART CONSTRUCTION
ADVANTAGE: EASY AND COST EFFECTIVE TRANSPORT



Top and bottom mounting plates are prepared for both square neck bolts and regular screws.

(Not included)



Art. Nr.	Height / mm	Price/£
1330 3500	3500	124.73

SLIDING POLES

MATERIAL: STAINLESS STEEL AISI 304

TUBE SIZE: 38x2MM

MOUNTING PLATE AT EACH END WITH TWO HOLES.

CAN BE USED AS A SINGLE SLIDONG POLE
OR AS TWO PIECES MOUNTED SIDE-BY-SIDE.

Art. No.	Bending Style	Price/£
1361	Wave	120.91
1362	Curve	120.91

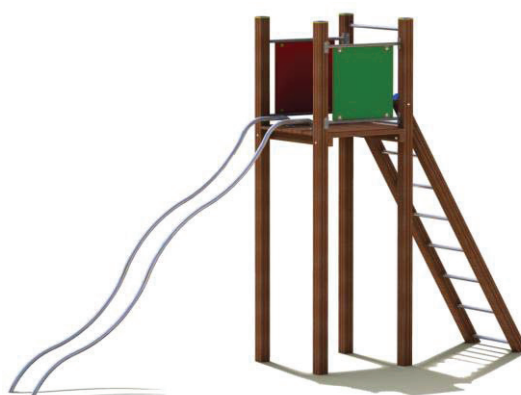
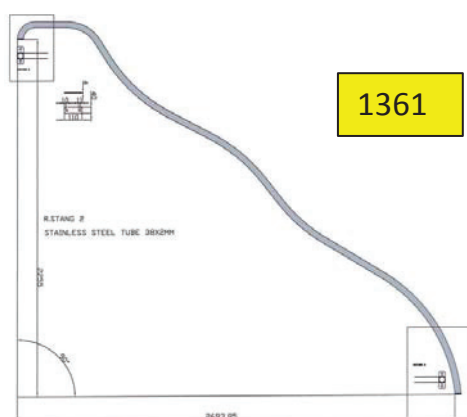
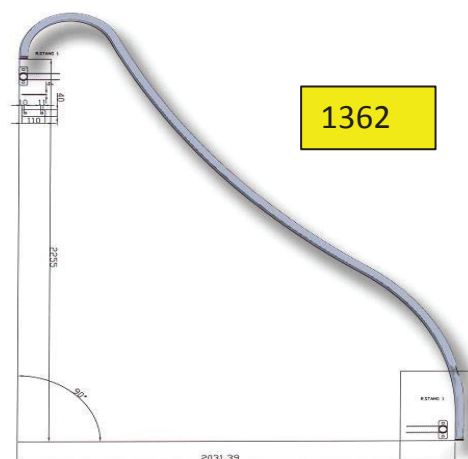

SLIDING POLE, PARALLEL MOUNTED WITH CROSS BAR.

MATERIAL: STAINLESS STEEL AISI 304

TUBE SIZE: 38x2MM

300MM DISTANCE BETWEEN THE TWO TUBES
WITH WAVES

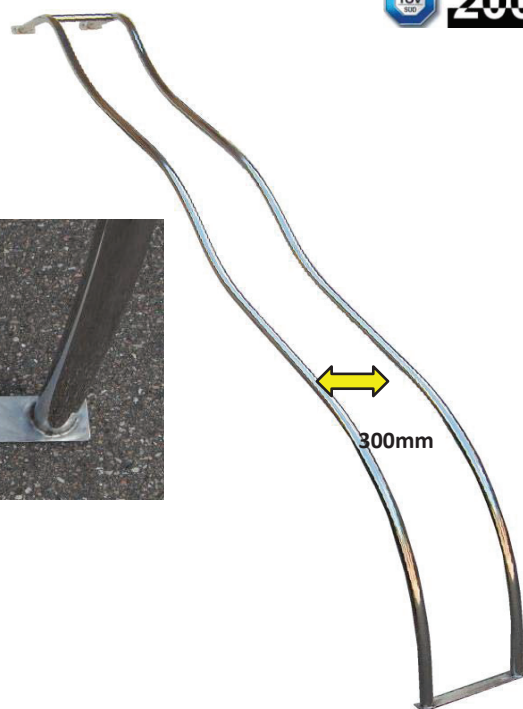

Art.No.	Heigh/mm	Quantity/ Order	Price/£ per piece
1363	2000MM	1 – 3 PCS	297.82-
1363	2000MM	4 – 6 PCS	282.55

SPIRAL SLIDING TUBE

MATERIAL TUBE Ø38x2MM,
STAINLESS STEEL AISI 304

MOUNTING HEIGHT MAX. 1680MM

APPROX. DIMENSIONS DIAMTER OF CIRCLE: 560MM
TOTAL LENGTH: 2700MM

NEW, DIFFERENT AND CHALLENGING PIECE OF PLAYGROUND EQUIPMENT. THE SPIRAL SLIDING TUBE IS MOUNTING FRIENDLY, AND EQUIPPED WITH A MOUNTING BRACKET WHICH CAN MOVE IN ORDER TO FIT THE PLATFORM. THE BOTTOM PART IS EQUIPPED WITH A MOUNTING PLATE FOR FIXASATION IN THE GROUND BY MEANS OF CONCRETE.

-TESTED AND APPROVED BY TÜV PRODUCT SERVICE
-ACCORDING TO EN1176

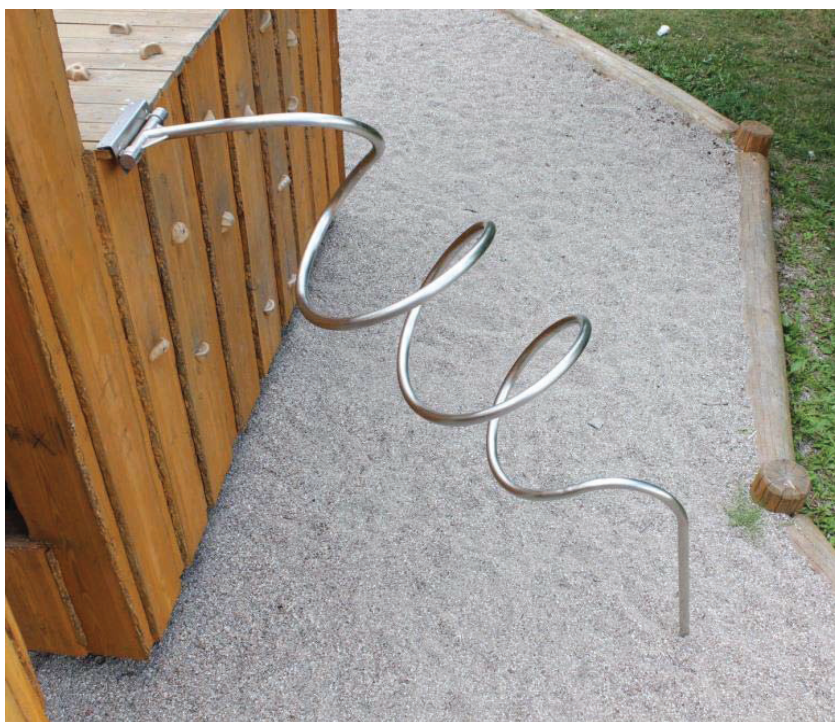

Art. No.	Height / mm	Quantity /Order	Price/£ Per Piece
1360 1500	1680MM	1-3PCS	280.00
1360 1500	1680MM	4-6PCS	273.64



TRAMPOLINE

Small model: (Art.no. 8700)
 Outer dimension 1500x1500mm
 Jumping area 1000x1000mm
 Safety area 4500x4500mm
 Weight 167Kgs.

Medium model: (Art.no. 8710)
 Outer dimension 1750x1500mm
 Jumping area 1250x1000mm
 Safety area 4750x4500mm
 Weight 214Kgs.

Medium+ model: (Art.no. 8714)
 Outer dimension 2000x2000mm
 Jumping area 1500x1500mm
 Safety area 5000x5000mm
 Weight Kgs

Big model: (Art.no. 8720)
 Outer dimension 3000x2000mm
 Jumping area 2500x1500mm
 Safety area 6000x5000mm
 Weight 355Kgs.

XL Model: (Art.no. 8730)
 Outer dimension 2500x2500mm
 Jumping area 2000x2000mm
 Safety area 5500x5500mm
 Weight Kgs

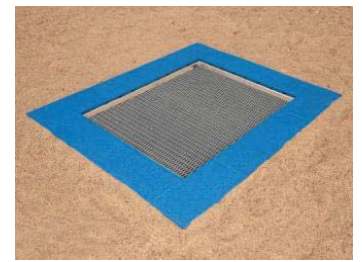

All models are delivered ready-to-install, including metal frame and surrounding rubber slabs. Jumping area consisting of heavy duty plastic segments in Black or Grey colour. The Trampolines are Equipped with hinges that allow for opening making cleaning easy. Certified by TÜV

Please note : Term of delivery: Ex. Works, Denmark

DIM.	Art. No.	Price/ £
1,50 x 1,50M	8700	1972.73
1,75 x 1,50M	8710	2316.36
2,00 x 2,00M	8714	3558.55
3,00 x 2,00M	8720	4258.55
2,50 x 2,50M	8730	4301.82

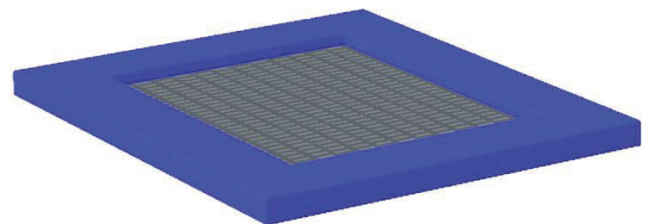

2015 | NEW SIZES

POST FOOT – GROUND ANCHOR

MATERIAL: HOT DIP GALVANIZED

DIMENSIONS

UPPER PART: 33,70 x 2,9 MM

GROUND SECTION: 60,30 x 3,6 MM

TOTAL HEIGHT: 950 MM

Art. No. 1500 1000		Price per piece
Quantity	Application	Price/£
25 Pieces	Round & Square	23.86
50 Pieces	Round & Square	20.36
100 Pieces	Round & Square	19.09
200 Pieces	Round & Square	18.45
500 Pieces	Round & Square	16.86
1000 Pieces	Round & Square	15.59

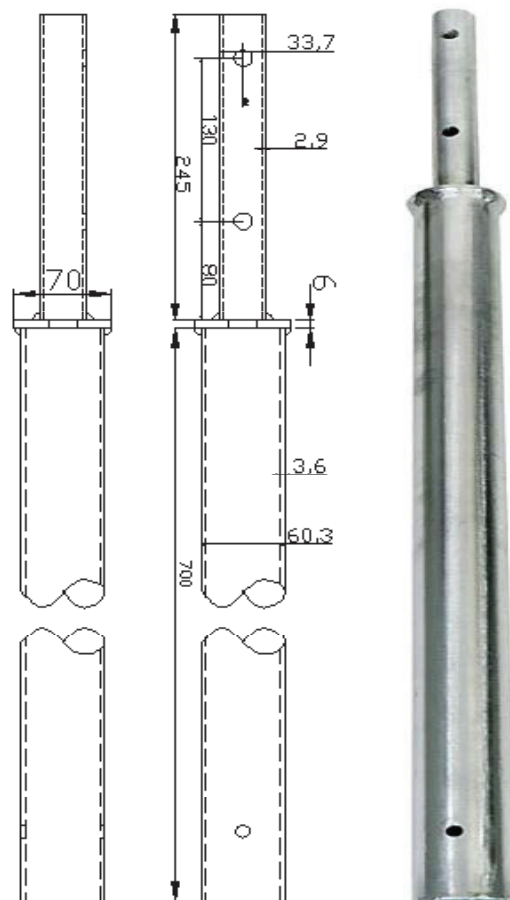

POST FOOT – GROUND ANCHOR

MATERIAL: HOT DIP GALVANIZED
L-STEEL PROFILE: 85x85x4MM (INNER DIM.)

Art. No. 1500 1000 SQ (SQUARE PROFILES)
Price per Piece

Quantity	Price/£
1-24 Pieces	47.41
25 Pieces	27.68
50 Pieces	25.14
150 Pieces	23.55
300 Pieces	22.27
600 Pieces	20.68

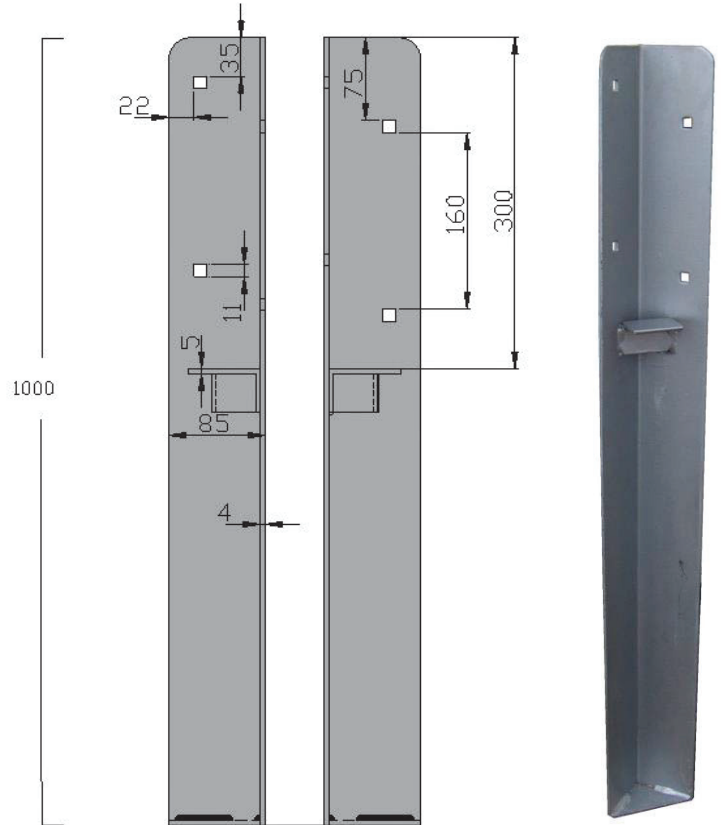

L=900

Art. No. 1500 900 100 (Ø100mm)

Art. No. 1510 900 (Ø120mm)

Art. No. 1500 900 (Ø160mm)

L=1100

1500 1100 (Ø140-160mm)

Price per set

Quantity	Price £	Price £
	L=900mm	L=1100mm
1-24 Sets	52.82	60.14
25 Sets	31.18	36.27
50 Sets	29.91	34.68
150 Sets	28.32	32.77
300 Sets	26.73	31.50
600+ Sets	25.45	30.23

**With Reinforced
U-Profile supporting the
timber.**

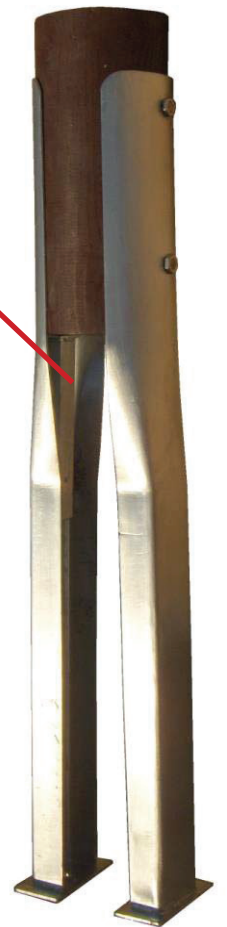
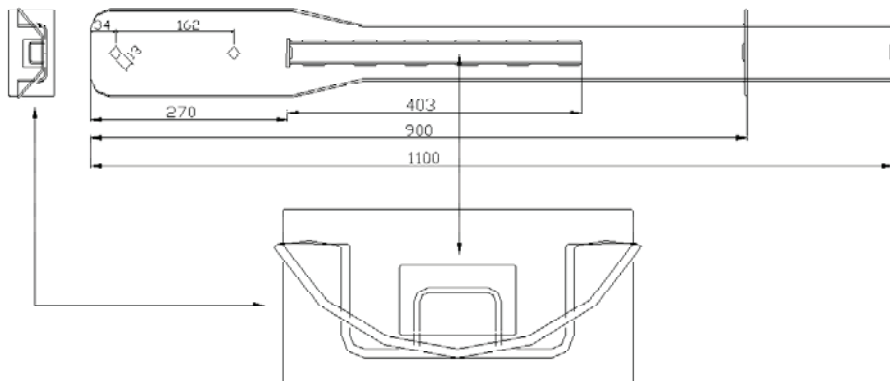

SURFACING MATS – LAWN MATS

ENVIRONMENTALLY FRIENDLY, NON-SLIP, AND ALLOWS FOR SAFETY FOR FOOT WAY SURFACES. IDEAL FOR LOW LEVEL TRAILS AND PATHWAYS ETC. WHEELCHAIR AND PUSHCHAIR ACCESSIBLE

BENEFITS:

- ABSORBS NOISE
- PROTECTS FLOOR AND EQUIPMENT
- REQUIRES NO SPECIAL SKILLS OR TOOLS
- ALLOWING A QUICK AND EASY INSTALLATION
- IDEAL FOR GREEN FIELDS SITES – DISAPPEARS FROM VIEW ONCE THE TURF HAS RE-GROWN
- CAN BE USED FOR CONTOURED LANDSCAPES
- SUITABLE FOR ALL WEATHER, EXTREME TEMP.
- RESISTS WIND UPLIFT

LARGE OPENINGS OF 25MM DIAMETER ALLOW LIQUID AND DEBRIS TO DRAIN, KEEPING SURFACE DRY AND CLEAN

DIMENSIONS ARE: 1000x1500x23MM

THE MATS MUST BE FASTENED BY MEANS OF CABLE TIES AND GROUND PEGS (INCLUDED).

Art. No.	Price/£
1480	25.00

PAH TEST: Compliance with ZEK 01-08 category 3

If required - additional pegs and cable ties are available - see below

Art. No.	Price/£
R5550 01 Additional Pegs, each	0.75
R5550 02 Additional Cable Ties, (Bag of 100 units)	4.00

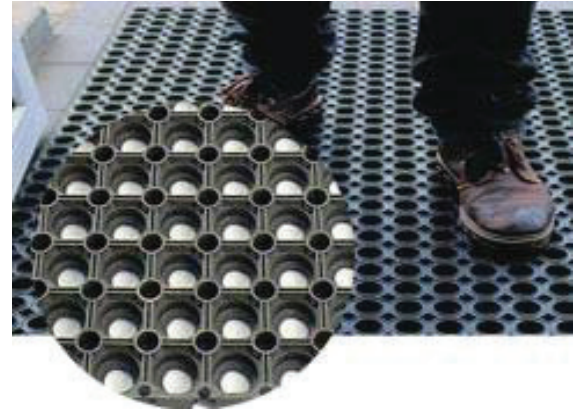
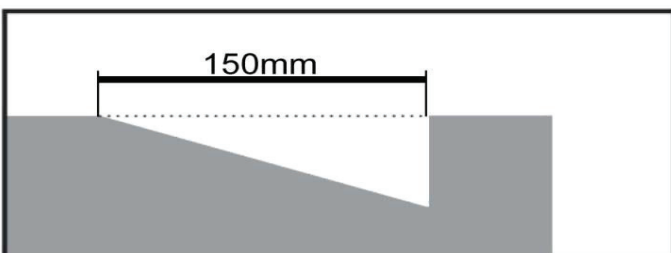

** Slight tolerances in dimensions can occur

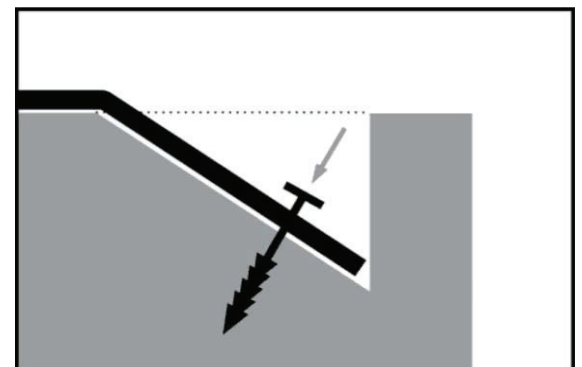
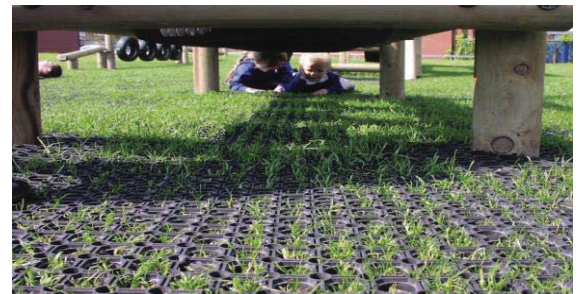

SAFETY SLABS

COLOURED RUBBER GRANULATE
SLABS INCLUDE SYSTEM PEGS
FOR CONNECTION.

Minimum 30m² per Order



Price per m² 500x500mm Including Pegs

Art. No.	Thickness	Falling Height	Price/£
1400 45	45mm	1.60 m	37.50
1400 65	65mm	2.00 m	49.50
1400 100	100mm	3.00 m	73.25
Cartridge for Punctuell Glueing on Asphalt or Concrete (310 ml.) One cartridge enough for approx. 3m ²			15.00

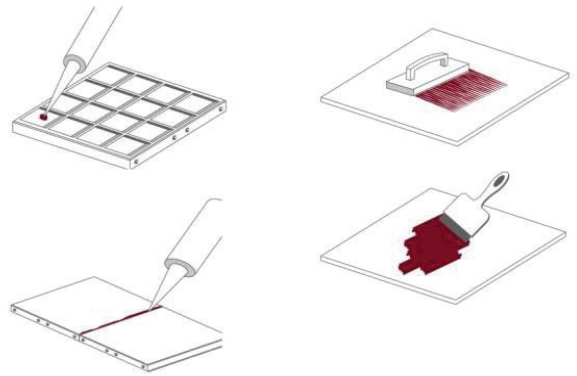

STANDARD COLOUR: RED/BROWN, ADDITIONAL COLOURS AGAINST A SURCHARGE OF £4.50 PER M².

SAND BOX MODULES

LENGTH'S OF 1000MM WITH GROUND ANCHOR - HEIGHT 390MM

Art. No.	Price per 1 Module of 1000mm	Price/£
5611	Including ground anchor	67.75

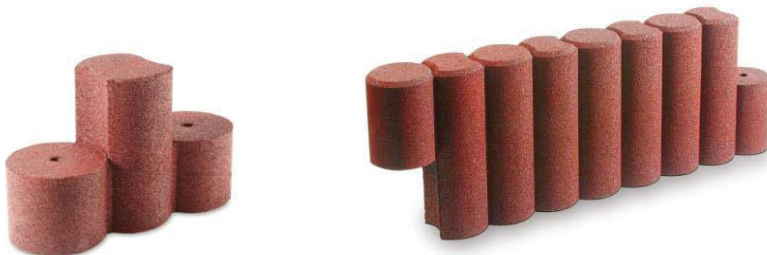

PLASTIC COMPONENTS

BOLT COVERS

CONSISTING OF TWO PARTS,
LOCK BY PRESSURE.

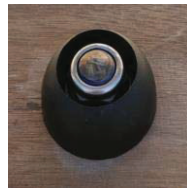

For Flat Surface
Art. No. 10-M10 BLA (M10)
Art. No. 10-M12 BLA (M12)

For Round Surface
Art. No. 10-M10 R60 BLA (M10)
Art. No. 10-M12 R60 BLA (M12)

Quantity	Price £/pcs
100pcs	0.55
1000pcs	0.52
5000pcs	0.47

Quantity	Price £/pcs
100pcs	0.65
1000pcs	0.61
5000pcs	0.55

FOOTREST / HAND GRIP

CONSISTING OF 3 PARTS AS SHOWN ON
DRAWING, APPLICATION FOR FLAT
SURFACES. ALSO AS HAND GRIPS

Art. No.	Price £/pcs
10-L90 BLA	3.95

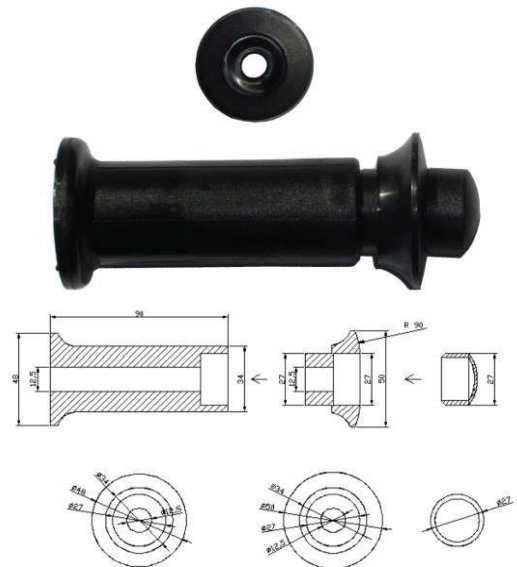

SPACER

SPACER SUITABLE FOR ROUND SURFACES
FASTENED BY SELF-TAPPING SCREW

MINIMUM ORDER QUANTITY 100PCS

Art. No.	Price £/pcs
10-SP 10-16 BLA	1.91



FREIGHT COSTS AND TERMS

Freight cost will always be charged separately, however below please find some estimates, based on February 2013 freight rates.

Playground spare parts Stainless steel Slides 500mm wide up to 1500mm platform height

Country	100 Kilo	1 Slide	5 Slides
United Kingdom	£ 120 to £142	£ 162 to £ 194	£ 390 to £ 457

Spare parts from 0-30 kilo will be dispatched with Parcel Post.

Administration Fee of £20 is applicable on all orders below £180.00 excluding the freight costs & VAT.

No right to return goods:

When buying B2B, there is no right to return goods; The customer has no right to return Playground Components bought B2B. Purchased goods can only be returned in exceptional cases and only with prior agreement. In case of a return, the following conditions will be applicable:

- A refund fee equivalent to 25% of the merchandise value will be charged
- Goods are only accepted in original packaging
- The return must take place within 60 days after billing date
- All emerging costs (e.g. freight costs, customs, etc.) are paid by the customer

Terms:

Ex Works , Denmark.

Payment:

According to agreement

Transport time:

Approx. 2 to 5 days.

Freight:

According to postal code.

Prices:

We reserve the right to edit our prices as a result of increase in raw material, labour costs and international currencies.

Technical specifications:

We strive to develop and improve our products, and as a result of this minor changes in the technical specifications may occur. Most products are TÜV certified. The relevant Certifications can be acquired on demand.

Legal disclaimer

Play and Sports Ltd cannot in any way be held responsible for any damage, material or personal, due to defective construction.

